

A(mm)	760 mm
B(mm)	50 mm
C(mm)	20 mm
D	Wlot powietrza
E	Wylot powietrza 5 mm

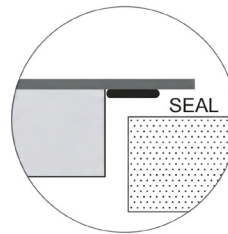
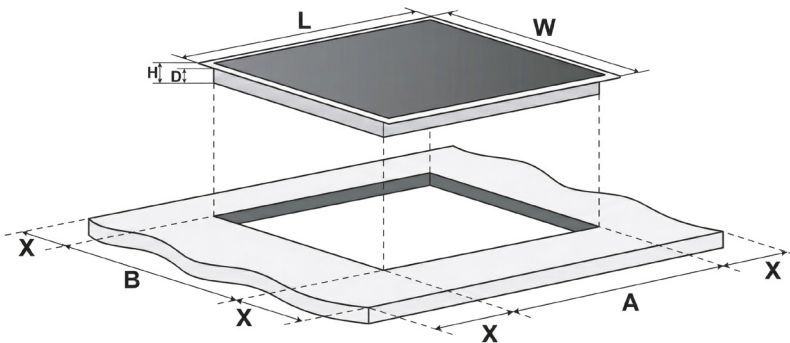

L(mm)	290 mm
W(mm)	520 mm
wys(mm)	58 mm
D(mm)	54 mm
A(mm)	270 mm
B(mm)	490 mm
X(mm)	50 mm

KERNAU

KIH 3214-2B